

Article number: 20285B14B122SW

Description: E+G Swivel clamp connector joint
GN285-B14-B12-2-SW

Measures

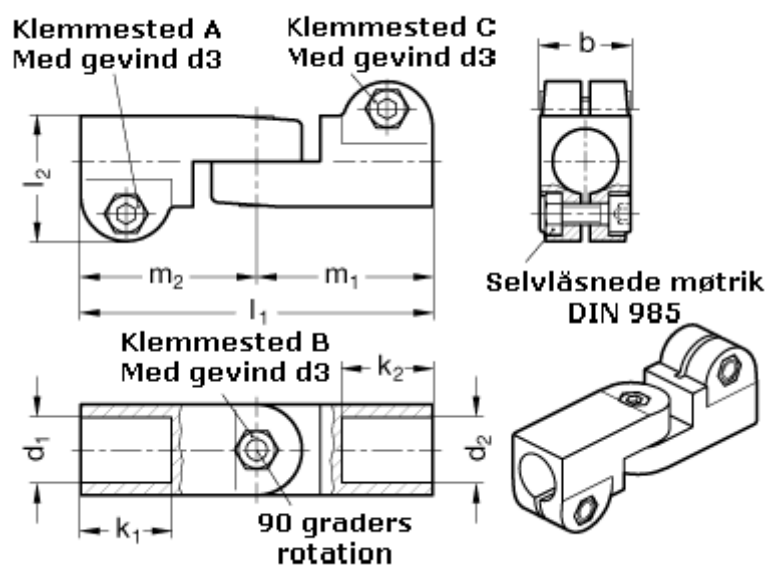

b = 25

m1 = 48.5

d1 = B14

m2 = 48.5

d2 = B12

d3 = M 6

k1 = 25

k2 = 25

l1 = 97

l2 = 34.5